

Branch Offices:

AHMEDABAD

B-802, Iscon Elegance,
Nr. Prahalad Nagar Corner,
Opp. Karnavati Club,
S.G. Highway- 380 051
Ph.: 079 - 66168835, 66168836
Fax : 079-66168837
E-mail: ahmedabad@hplindia.com

BANGALORE

No.2D, IInd Floor, Farah Winsford,
133, Infantry Road, Bangalore - 560 001
Ph.: 080-22863068 Telefax : 080-22863069
E-mail: bangalore@hplindia.com

BHUBANESWAR

N3-135, IRC Village, Nayabali,
Behind Od Sai Baba Temple,
Bhubaneswar-751 012
Ph.: 0674-6538229 Telefax : 0674-2550826
E-mail: orissa@hplindia.com

CHANDIGARH

Plot No.57, Phase-1, Industrial &
Business Park, Chandigarh-160002
Telefax.: 0172-5077815, 5049425
E-mail : chandigarh@hplindia .com

CHENNAI

"Amar Sindur" S-4, 2nd Floor,
No.-43, Pantheon Road, Egmore,
Chennai-600 008
Ph.: 044-28551530, 28551537
Fax : 044-42638243
E-mail: chennai@hplindia.com

COCHIN

2nd Floor, A.K.S. Mahal Building,
XL/7813J, Achutha Warriar Lane,
M.G.Road,Ernakulam,Cochin-682 035
Telefax : 0484-2354595
E-mail: cochin@hplindia.com

COIMBATORE

Designer Complex,
Door No.130, C Part-2, 2nd Floor,
Dr. Nanjappa Road,Coimbatore - 641018
Ph.:0422-4393995
E-mail : coimbatore@hplindia.com

DEHRADUN

R/09/4/6, 1st Floor, East Canal Road,
Dehradun-248001
Ph.: 0135-2710567, 2710587
E-mail: Utranchal@hplindia.com

GUWAHATI

Rajgarh Road, Opposite China Town
Restaurant Guwahati - 781 003
Ph.: 0361-2450889
E-mail: guwahati@hplindia.com

HUBLI

9-10, 1st Floor, Vernekar Plaza,
Desh Pande Nagar, Hubli-580029
Ph.: 0836-4251463
E-mail : hubli@hplindia.com

HYDERABAD

No. 7-1-58, flat No.403, 4th Floor,
Concourse Building, Green
Lands Road, Hyderabad - 500 016
Ph.: 040-23740567,66687878,66773117
Telefax: 040-40035959
E-mail: hyderabad@hplindia.com

INDORE

203, Millinda Manor 2 RNT Marg,
Near Ravindra Natya Grah,Indore- 452 001
Ph.: 0731-4280525 Fax: 0731-2015658
E-mail: Indore@hplindia.com

JABALPUR

RAJUL LANDMARK
1st Floor Shop No.-101
Opposite Jabalpur Hospital
Russel Chowk, Jabalpur-482002
Ph.: 9407154296
E-mail : mishra@hplindia.com

JAIPUR

512, 5th floor, Plot No. 8-9,
Corporate Park, Gopal Badi,
Ajmer Road Jaipur - 302 001
Ph. : 0141-4021035, 4018426
E-Mail: jaipur@hplindia.com

JAMMU

Plot No.86 Yard No.6
Transport Nagar, Jammu- 180006
E-mail: jammu@hplindia.com

KANPUR

17/14, 2nd Floor, Opposite Nanarao Park,
The Mall, Kanpur - 208 001 (U.P.)
Ph.: 0512-2316017 Telefax: 0512-2353743
E-mail: kanpur@hplindia.com

KOLKATA

69, Ganesh Chandra Avenue, India House
7th Floor, Block-C, Kolkata - 700 013
Ph.: 033-65394379 Fax :033-22252716
E-Mail: calcutta@hplindia.com

LUCKNOW

1st Floor, Jain Building, 14/A5,
Park Road Hazratganj ,Lucknow
Ph.: 0522-4021687
E-Mail: lucknow@hplindia.com

LUDHIANA

698 - D , Model Town, Extn.,
Ludhiana-141 001
E-Mail : ludhiana@hplindia.com

MUMBAI

2H, Rushabh Chambers 2nd Floor,
Off-Makwana Road, Near Rubi Hotel Marol
Andheri East Mumbai - 400 059
Ph.: 022-61830810-20 Telefax: 022-28528181
E-mail: mumbai@hplindia.com

NAGPUR

Jagtap House, Plot No. 07,
1st Floor, Ganesh Gruh Nirman Society,
Near Ganesh Mandir, Ring Road, Pratap Nagar,
Nagpur - 440022, Ph.: 0712-2222988
E-mail: nagpur@hplindia.com

PATNA

Bhagat Sadan, Sahi Lane,
S. P. Verma Road, Patna - 800001 (Bihar)
Ph. : 0612-2216500
E-mail: patna@hplindia.com

PUNE

15, 4th Floor The Millennium
Apartment Anove Krishna Pearls,
Nal Stop Karve Road, Pune - 411 004
Ph. : 020-66004041,42,43,44,45
Fax: 020-66004046
E-mail: pune@hplindia.com

RAIPUR

1st Floor, Near Holy Heart School
Chattisgarh College Road, Civil Line,
Raipur (C.G.)-492 006 Ph.:0771-6541590
E-mail : raipur@hplindia.com

RANCHI

203, Mahalaxmi Complex,Link Tank
Road, Near Bargain Bazar, 2nd Floor
Ranchi - 834 001 Telefax : 0651-2206144
E-mail : ranchi@hplindia.com

SILIGURI

Parasuna Bhawan, Ward No.13,
Udham Singh Sarani, Asram Para,
Siliguri-734001

VADODARA

409/410, Silver Oak Complex,
Near Sainik Park Char Rasta,
Productivity Road, Akota,
Vadodara - 390020 Gujarat
Ph.: 0265-2341747 Fax:0265-2352107
E-mail : baroda@hplindia.com

VIJAYAWADA

D.No.-29-37-137, 2nd Floor,
G. R. Plaza, Beside Canara Bank,
Eluru Road, Vijayawada-520 002
Ph.: 0866-6622291 Fax:0866-2442275
E-mail : vijayawada@hplindia.com

VIZAG

B.K. Towers, 49-34-1/63, 3rd Floor
Akka Yyapalem Main Road, NH-5 Junction,
Vizag-530 016 (A.P.)
Ph.: 0891-2794506, 6461730
Fax:0891-2743531
E-mail : vizag@hplindia.com

Resident Offices:

Agartala	Balasure	Davangere	Jharsuguda	Moradabad	Silchar	Vapi
Agra	Belgaum	Durg	Jodhpur	Mysore	Surat	Varanasi
Allahabad	Berhampur	Goa	Kanyakumari	Nagercoil	Sholapur	Vellore
Anantpuram	Bhilai	Gorakhpur	Kolhapur	Nasik	Srinagar	
Aurangabad	Bhopal	Gulbarga	Kota	Patiala	Sambalpur	
Amravati	Bilaspur	Jabalpur	Madurai	Pondicherry	Tirupati	
Akola	Bijapur	Jabli	Malda	Rajkot	Trichy	
Angul	Calicut	Jamshedpur	Mangalore	Rourkela	Trivandrum	
Bareilly	Cuttack	Jalandhar	Meerut	Salem	Udaipur	

Works:

• Gurgaon - Haryana • Sonapat - Haryana • Kundli - Haryana • Karnal - Haryana • Jabli - Himachal Pradesh

Customer Cell : 011-23235274



HPL Electric & Power Ltd.

Corporate Office : 1/21, Asaf Ali Road, New Delhi - 110 002, INDIA
Tel.:+91-11-23234411, 23234811, 23236811, Fax :+91-11-23232639
E-mail : hpl@hplindia.com

www.hplindia.com

“HPL LED
Brings light to lighting”

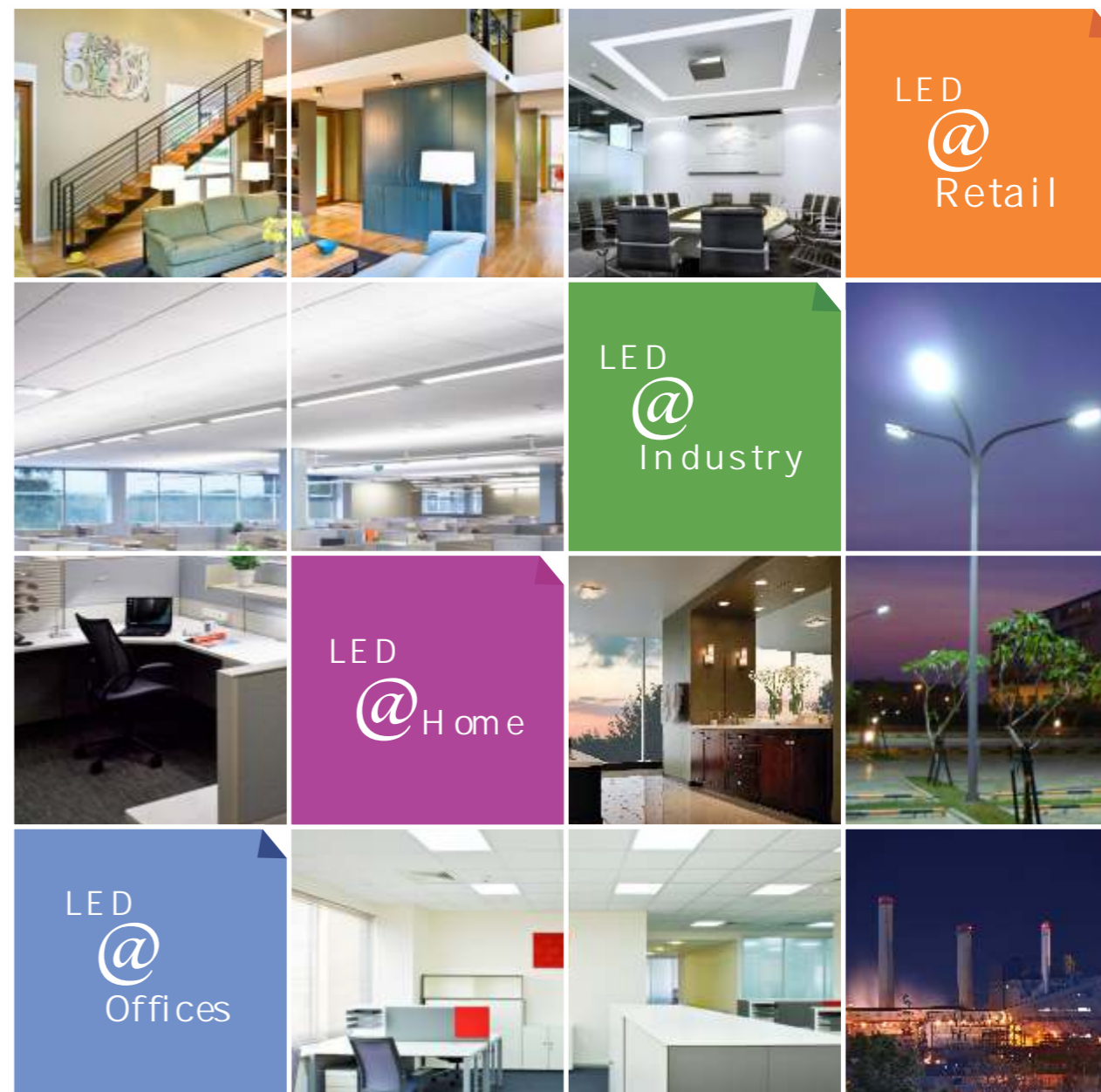

Professional
LED Catalogue



POWER OF TECHNOLOGY

LED LIGHTING

About Us

Founded in 1956 and displaying an unwavering commitment to the creation of world-class quality products ever since, the HPL Group has created a niche for itself in the electrical industry. Today, HPL is regarded as “The Technology Brand of India” and is one of the premium manufacturers of reliable Electrical Protection Equipments, Switchgears, Electronic Energy Meters and Energy Management Systems. Consistent and sound policies have helped the HPL Group mark a strong presence nationally as well as globally.

A fast growing company that boasts of more than 3000 dealers, HPL continuously keeps adding new products to its already impressive portfolio. Modular Switches are the latest addition to the range. Social and environmental responsibility has been at the forefront of HPL’s operating philosophy and the company consistently contributes to socially responsible activities. Our geographical reach across market segments and our ability to cater to new requirement of the customer with smart solutions makes us a multipolar group.

HPL product profile’s unparalleled domain expertise is reflected in the following strategic business units:

- LV Switchgears
- LV Protection Devices
- Modular Switches
- Metering and Energy Management System
- LED Lighting
- Luminaries.
- Wires & Cables

HPL takes pride in its networking to support and augment the product line. HPL Group with its Head Office at New Delhi has extensive sales and marketing network of 69 branches including resident representatives, over 3000 Authorized Dealers and 27000 retailers across the country, who are committed to provide solutions and services to customers’ delight.



CONTENT





POWER OF TECHNOLOGY

LIGHTING

LED Benefits

20% OF THE WORLD'S ENERGY USE OF THE LIGHTING



THIS COULD BE REDUCED TO JUST 4% WITH LED LIGHTING

1

30 incandescent Bulb



LED Bulb



you will throw away about 30 incandescent for every 1 LED

2



3

4

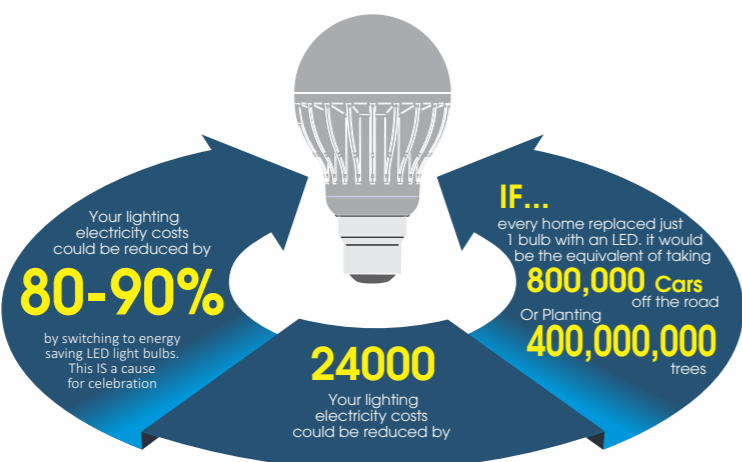

Consumer Benefits



Energy Savings

Highly efficient leds ensures saving upto 50%



Sleek & Compact Design

Elegantly designed fittings which ensures large stream of applications – offices, Residentials, Hotels, Restaurants, Shopping Malls and Hospitality.



long life 30000 hrs.

Long Life

The life of Led is 5-6 times of CFLs', which makes a perfect lighting solution as it ensures high energy saving with long service life



Maintenance free

Maintenance Free

The highly efficient electronic drivers ensures maintenance free and long service life



Eco Lighting Solution

Led lighting is a pollution free solution without any mercury or lead content .





Industrial Lighting

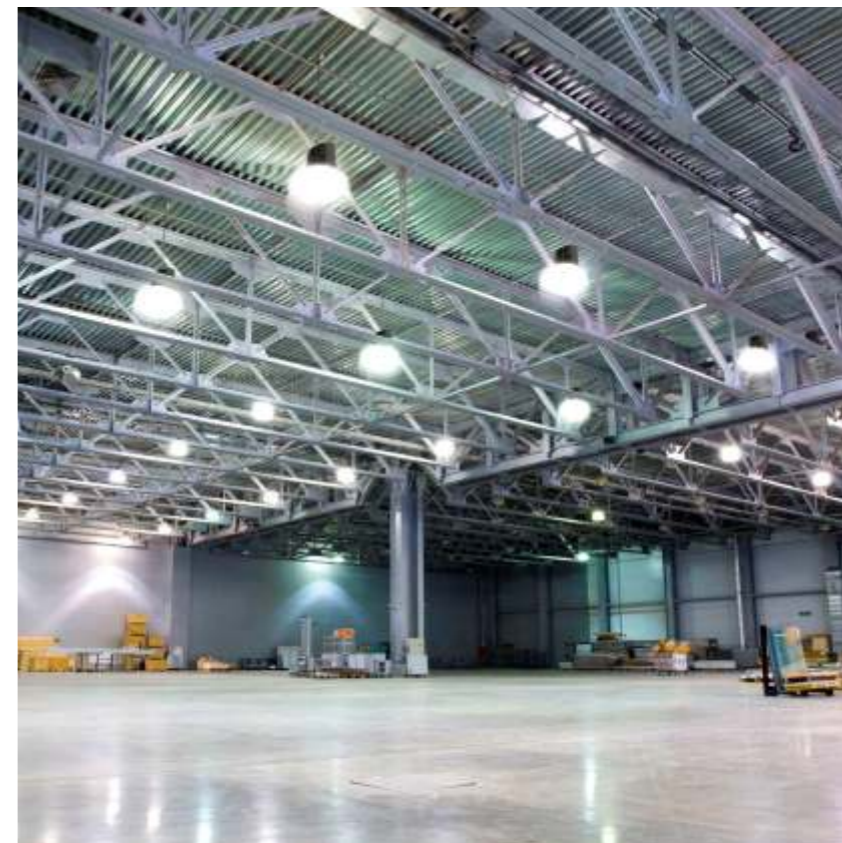

LED Warehouse Lighting insures optimum productivity and ease of navigation by providing phenomenal lighting in your warehouse or industrial facility. High and low bay lighting along with powerful heavy duty heat sink . These superior quality LED high bay luminaire fixtures offer maximum energy savings, reduce maintenance costs.



LED Strom

Product Features

- Made up of corrosion resistant unbreakable poly carbonate body
- High quality PC cover for LED linear lamp ensures soft and glare free lighting
- Specially designed aluminum housing for excellent Heat dissipation
- Ensures IP65 Protection
- Aesthetically designed gas kit for better heat dissipation and protection support

Applications



Product Dimensions

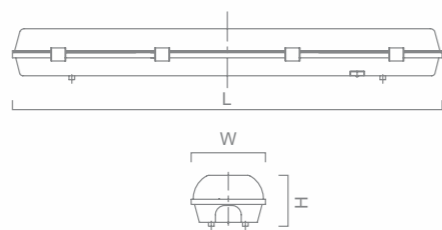

Wattage	'L' Length	'W' Width	'H' Height
(1x18)	1200mm	100mm	110mm
(2x18)	1200mm	160mm	110mm
(1x20)	1270mm	100mm	110mm
(2x20)	1270mm	160mm	110mm

Polar Diagram

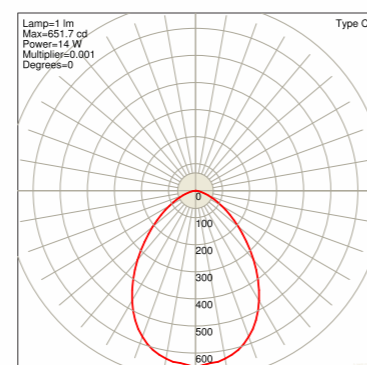

Product Descriptions	Product Code	Power (W)	Lumen (lm)	CRI	CCT	PF
LED Strom AL 1x20W	HPLLEDWT820(CW)	20	2000	80	6000-6500k	0.95
LED Strom AL 2x20W	HPLLEDWT840(CW)	40	4000	80	6000-6500k	0.95
LED Strom PC 1X18W	HPLLEDWT8PC18(CW)	18	2000	80	6000-6500k	0.95
LED Strom PC 2X18W	HPLLEDWT8PC36(CW)	18	4000	80	6000-6500k	0.95
LED Strom PC 1X20W	HPLLEDWT8PC20(CW)	20	2000	80	6000-6500k	0.95
LED Strom PC 2X20W	HPLLEDWT8PC40(CW)	40	4000	80	6000-6500k	0.95



LED Legacy

Product Features

- High quality PC cover for LED linear lamp ensures soft and glare free lighting
- Specially designed aluminum housing for excellent Heat dissipation
- Aesthetically designed box type industrial fixture
- Industrial Batten suitable for use with single or twin LED Tube
- CRCA Sheet steel coated housing in white to improve resistance against corrosion

Applications



Product Dimensions

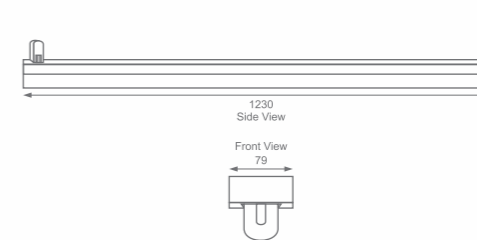

Wattage	'L' Length	'W' Width	'H' Height
18/20W	1230	53mm	79mm
36/40W	1230	102mm	77mm

Polar Diagram

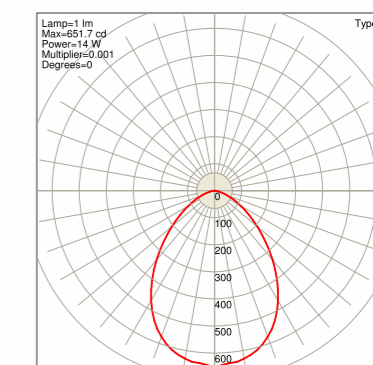

Product Descriptions	Product Code	Power (W)	Lumen (lm)	CRI	CCT	PF
LED Legacy AL 1x20W	HPLLEDT820(CW)	20	2000	80	6000-6500k	0.95
LED Legacy AL 2x20W	HPLLEDT840(CW)	40	4000	80	6000-6500k	0.95
LED Legacy PC 1X18W	HPLLEDT8PC18(CW)	18	1800	80	6000-6500k	0.95
LED Legacy PC 2X18W	HPLLEDT8PC36(CW)	36	3600	80	6000-6500k	0.95
LED Legacy PC 1X20W	HPLLEDT8PC20(CW)	20	2000	80	6000-6500k	0.95
LED Legacy PC 2X20W	HPLLEDT8PC40(CW)	40	4000	80	6000-6500k	0.95



Highbay

Product Features

- Range: 70W/90W/100W/120W/150W/180W & 200W
- Highly efficient heat sink designed to ensure prolong the life span of the LED.
- Efficiently designed constant current driver with wide range input voltage 140V to 285V.
- Significantly lower running cost as compared to conventional fixtures.
- Available with toughened glass.
- Ingress Protection (IP-65).

Applications



Product Dimensions

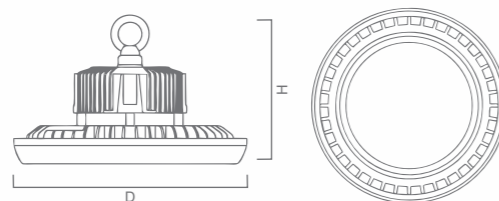

Wattage	'D' Diameter	'H' Height
70W	385mm	275mm
90W	385mm	275mm
120W	385mm	275mm
150W	428mm	275mm
180W	428mm	275mm
200W	428mm	275mm
240W	428mm	275mm

Polar Diagram

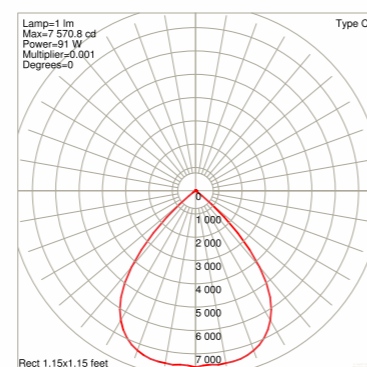

Product Descriptions	Product Code	Power (W)	Lumen (lm)	CRI	CCT	PF
LED Highbay 70W	HLPLEDHB070(CW)	70	8400	70	6000-6500k	0.95
LED Highbay 90W	HLPLEDHB090(CW)	90	10800	70	6000-6500k	0.95
LED Highbay 120W	HLPLEDHB120(CW)	120	14400	70	6000-6500k	0.95
LED Highbay 150W	HLPLEDHB150(CW)	150	15000	70	6000-6500k	0.95
LED Highbay 180W	HLPLEDHB180(CW)	180	18000	70	6000-6500k	0.95
LED Highbay 200W	HLPLEDHB200(CW)	200	20000	70	6000-6500k	0.95
LED Highbay 240W	HLPLEDHB240(CW)	240	24000	70	6000-6500k	0.95



Well Glass

Product Features

- Integral radial fins on housing for effective heat dissipation
- High power, high efficiency LED chip
- White powder coated internal reflector
- Thermally isolated driver and optical compartment
- Specially designed for IP66 protection

Applications



Product Dimensions

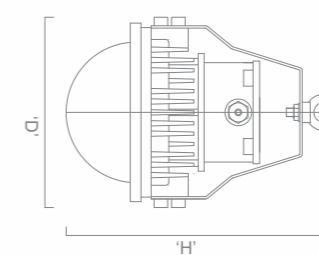

Wattage	'D' Length	'H' Height
30W	180mm	265mm
40W	180mm	265mm

Polar Diagram

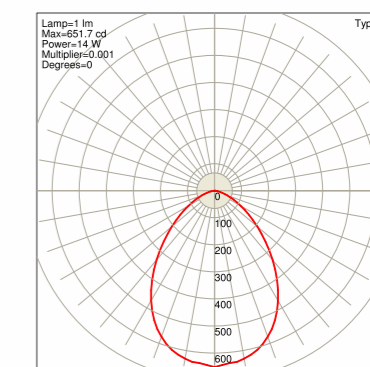

Product Descriptions	Product Code	Power (W)	Lumen (lm)	CRI	CCT	PF
LED Well Glass 30W	HLPLEDWG9030CW	30	3000	70	5700-6500k	0.95
LED Well Glass 40W	HLPLEDWG9040CW	40	4000	70	5700-6500k	0.95
LED Well Glass 70W	HLPLEDWG9070CW	70	7000	70	5700-6500k	0.95



Canopy Light

Product Features

- Replacement of conventional luminaries with low wattage canopy luminaries helps.
- Designed with secondary lenses for uniform distribution.
- Specially designed aluminum housing for excellent Heat dissipation.
- Ensures IP65 Protection.
- Aesthetically designed gas kit for better heat dissipation and protection support.

Applications



Product Dimensions

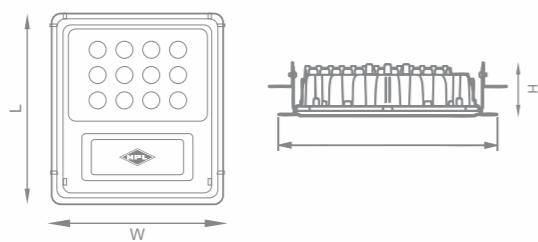

Wattage	'L' Length	'W' Width	'H' Height
40W	330mm	300mm	80mm
80W	335mm	305mm	80mm

Polar Diagram

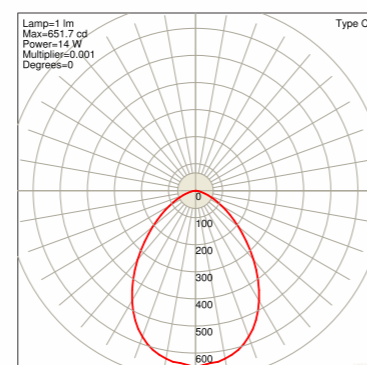

Product Descriptions	Product Code	Power (W)	Lumen (lm)	CRI	CCT	PF
Canopy Light 40W	HLPLEDCN40CW	40	6000	70	5500-6500K	0.95
Canopy Light 60W	HLPLEDCN60CW	60	6000	70	5500-6500K	0.95
Canopy Light 80W	HLPLEDCN80CW	80	8000	70	5500-6500K	0.95
Canopy Light 100W	HLPLEDCN100CW	100	10000	70	5500-6500K	0.95



Bulk Head

Product Features

- Available in 10W
- Made of pc housing
- Glare free inwhite color housing
- IP 65

Applications



Product Dimensions

Wattage	'L' Length	'W' Width	'H' Height
10W	207mm	77mm	70mm
20W	207mm	77mm	70mm

Polar Diagram

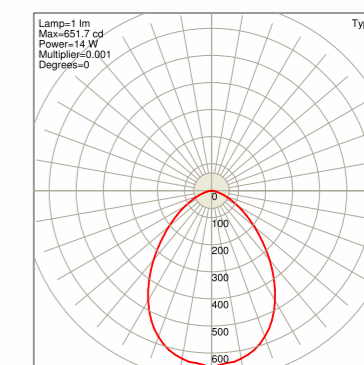

Product Descriptions	Product Code	Power (W)	Lumen (lm)	CRI	CCT	PF
Bulk Head 10W	HLPLEDBH10W(CW)	10	1000	80	5500-6500K	0.9
Bulk Head 20W	HLPLEDBH20W(CW)	20	2000	80	5500-6500K	0.9



Architectural Lighting



Decorative lighting is the fourth layer of interior illumination and, simply put, it is like jewelry for the home: it helps your space sparkle and shine. Accessorize your house and bring out its best features by adding decorative lighting fixtures.



Linear Recess

Product Features

- Grade Ceiling recessed mount linear LED Luminaire.
- Housing made of high pressure extruded aluminum construction, Die-cast aluminum end caps with no visible screws.
- UV and Corrosion resistance, with durable, anti-fading and available with different color body finish.
- Lighting distribution with Germany imported high transmittance PMMA diffuser.
- Best solutions for work station & officelighting.

Applications



Product Dimensions

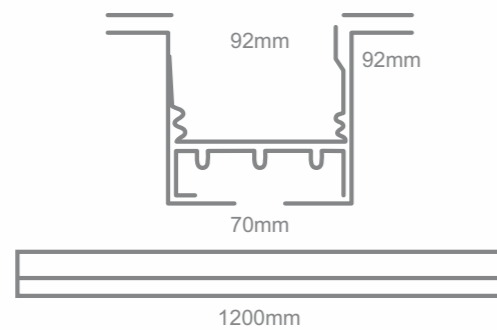

Polar Diagram

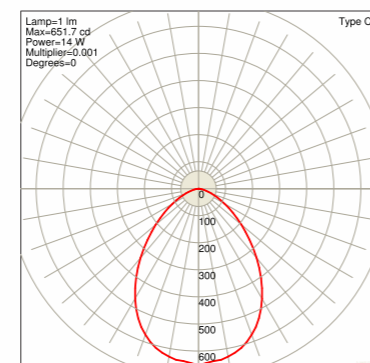

Product Descriptions	Product Code	Power (W)	Lumen (lm)	CRI	CCT	PF
Linear 20W	HPLLNR20	20	2000	80	3000-6000K	0.9
Linear 40W	HPLLNR40	40	4000	80	3000-6000K	0.9



Linear Suspended

Product Features

- Grade Ceiling suspended mount linear LED Luminaire.
- Housing made of high pressure extruded aluminum construction, Die-cast aluminum end caps with no visible screws.
- UV and Corrosion resistance, with durable, anti-fading and available with different color body finish.
- Lighting distribution with Germany imported high transmittance PMMA diffuser.
- Best solutions for work station & officelighting.

Applications



Product Dimensions

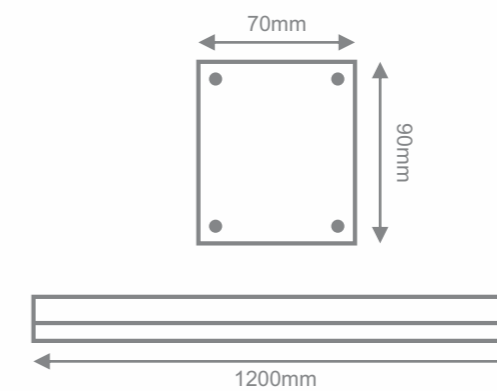

Polar Diagram

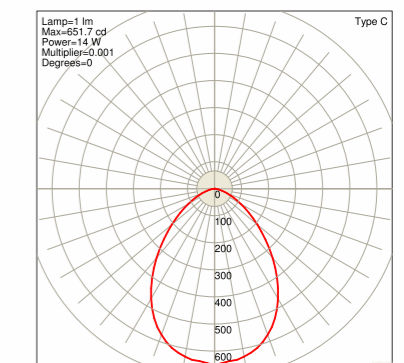

Product Descriptions	Product Code	Power (W)	Lumen (lm)	CRI	CCT	PF
Linear 30W	HPLSPD30	30	3000	80	3000-6000K	0.9
Linear 60W	HPLSPD60	60	6000	80	3000-6000K	0.9



Rays

Product Features

- Housing made of CRCA Die formed housing, UV and corrosion resistance, with durable, anti-fading and anti-scratch Electrostatic
- Thermo-painting finish in Architectural White black grey etc.
- High transmittance PC diffuser specially designed for LED light source creating smooth and uniform lighting distributions.
- Comfort for all lighting applications.
- Fixed direct distribution only advanced thermal management technology to ensure consistency of LED life span.
- Available in Suspended & Surface

Applications



Product Dimensions

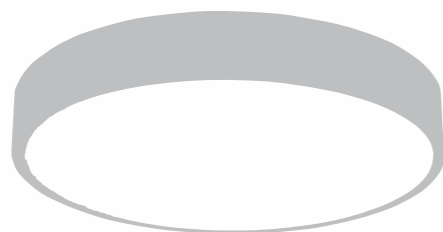

Wattage	'D' Dia	'H' Height
30W	400mm	100mm
45W	500mm	100mm

Polar Diagram

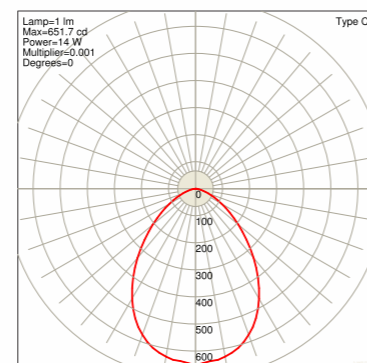

Product Descriptions	Product Code	Power (W)	Lumen (lm)	CRI	CCT	PF
Rays 30W	HPLRYS40030	30	3000	80	3000-6000K	0.9
Rays 45W	HPLRYS50045	45	4500	80	3000-6000K	0.9



Milan

Product Features

- Housing made of CRCA Die formed housing, UV and corrosion resistance, with durable, anti-fading and anti-scratch Electrostatic
- Thermo-painting finish in Architectural White black grey etc.
- High transmittance PC diffuser specially designed for LED light source creating smooth and uniform lighting distributions.
- Comfort for all lighting applications.
- Fixed direct distribution only advanced thermal management technology to ensure consistency of LED life span.

Applications



Product Dimensions



Polar Diagram

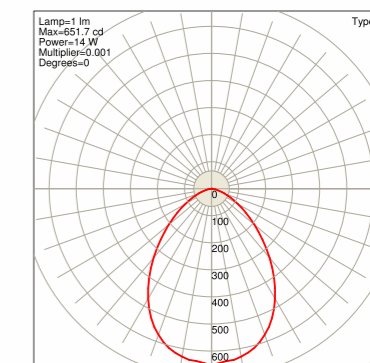

Product Descriptions	Product Code	Power (W)	Lumen (lm)	CRI	CCT	PF
Milan 45W	HPLMLN45	45	4500	80	3000-6000K	0.9

Note: Custom Wattage, Shape, Size & Powder Coating Colour available on request



Trios

Product Features

- Housing made of CRCA Die formed housing, UV and corrosion resistance, with durable, anti-fading and anti-scratch Electrostatic
- Thermo-painting finish in Architectural White black grey etc.
- High transmittance PC diffuser specially designed for LED light source creating smooth and uniform lighting distributions.
- Comfort for all lighting applications.
- Fixed direct distribution only advanced thermal management technology to ensure consistency of LED life span.

Applications



Product Dimensions



Wattage	'D' Dia	'H' Height
20W	400mm	100mm
30W	500mm	100mm
50W	600mm	100mm
70W	900mm	100mm

Polar Diagram

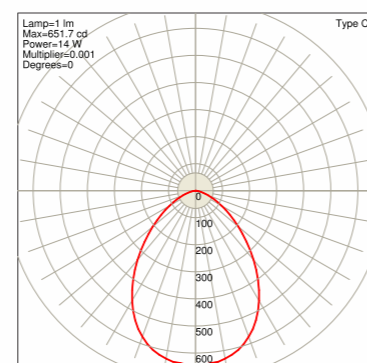

Product Descriptions	Product Code	Power (W)	Lumen (lm)	CRI	CCT	PF
Trios 20W	HPLTR20	20	2000	80	3000-6000K	0.9
Trios 30W	HPLTR30	30	3000	80	3000-6000K	0.9
Trios 50W	HPLTR50	50	5000	80	3000-6000K	0.9
Trios 70W	HPLTR70	70	7000	80	3000-6000K	0.9



Polo

Product Features

- Housing made of CRCA Die formed housing, UV and corrosion resistance, with durable, anti-fading and anti-scratch Electrostatic
- Thermo-painting finish in Architectural White black grey etc.
- High transmittance PC diffuser specially designed for LED light source creating smooth and uniform lighting distributions.
- Comfort for all lighting applications.
- Fixed direct distribution only advanced thermal management technology to ensure consistency of LED life span.

Applications



Product Dimensions



Wattage	'D' Dia	Inner Dia	'H' Height
30W	600mm	400mm	100mm

Polar Diagram

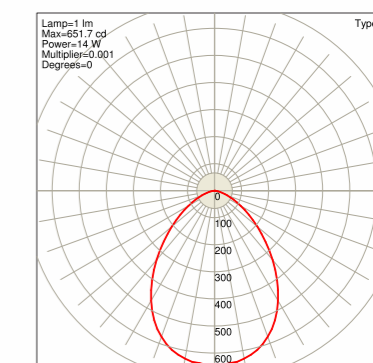

Product Descriptions	Product Code	Power (W)	Lumen (lm)	CRI	CCT	PF
Polo 30W	HPL600P30	30	3000	80	3000-6000K	0.9



Zoom (IP-20) Round

Product Features

- Simple and easy integrative structure design, easy in installation
- Housing made up of high heating conductive pure aluminum material
- High quality COB chip with uniform colour temperature , high lumen efficacy and long life span
- Aesthetically designed reflector for optimum optics control
- Highly efficient constant current drivers with additional protections

Applications



Product Dimensions

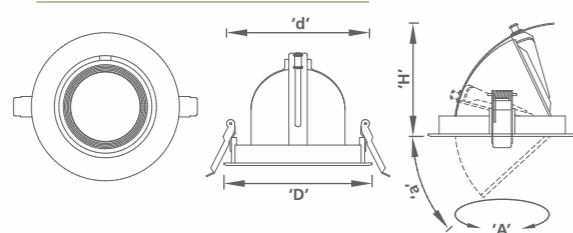

Wattage	'D' Diameter	'd' Cutout dia	'H' Height	'a' Tilting Angle	'A' Rotating Angle
10W	145mm	140mm	115mm	0-45°	±170°
20W	178mm	175mm	150mm	0-50°	±170°
30W	214mm	208mm	170mm	0-50°	±170°

Polar Diagram

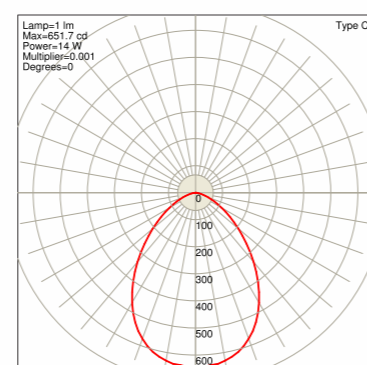

Product Descriptions	Product Code	Power (W)	Lumen (lm)	CRI	CCT	PF
Zoom 10W (R)	HLPLEDZRMB10CW	10	800	80	6000-6500K	0.95
Zoom 20W (R)	HLPLEDZRMB20CW	20	1600	80	6000-6500K	0.95
Zoom 30W (R)	HLPLEDZRMB30CW	30	2400	80	6000-6500K	0.95



Zoom (IP-20) Square

Product Features

- Simple and easy integrative structure design, easy in installation
- Housing made up of high heating conductive pure aluminum material
- High quality COB chip with uniform colour temperature , high lumen efficacy and long life span
- Aesthetically designed reflector for optimum optics control
- Highly efficient constant current drivers with additional protections

Applications



Product Dimensions

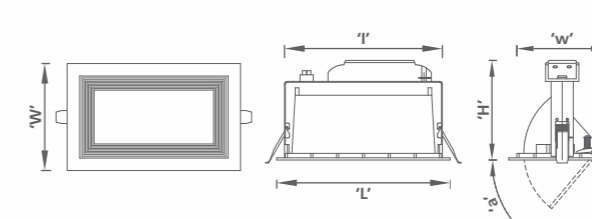

Wattage	'L' Length	'W' Width	'H' Height	'l' Cutout Length	'w' Cutout Width	'a' Tilting Angle
30W	235mm	146mm	135mm	220mm	125mm	0-50°
45W	235mm	146mm	125mm	220mm	125mm	0-50°

Polar Diagram

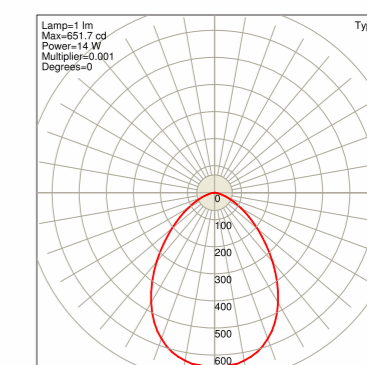

Product Descriptions	Product Code	Power (W)	Lumen (lm)	CRI	CCT	PF
Zoom 30W (Sq)	HLPLEDZSQWB30CW	30	3000	80	6000-6500K	0.95
Zoom45W (Sq)	HLPLEDZSQWB45CW	45	4500	80	6000-6500K	0.95



Step Light

Product Features

- Recessed mounted LED step light
- Aesthetically Designed high grade aluminum die cast housing
- High efficiency Led's for optimum light output and savings in power
- Short circuit & surge protection for enhanced reliability and longer service life of driver

Applications



Product Dimensions

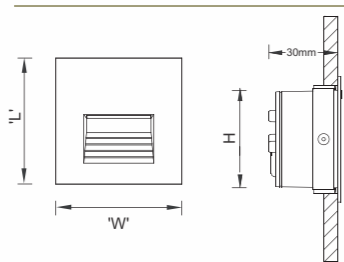

Wattage	'L' Length	'W' Width	'H' Height
1W	85mm	85mm	35mm
3W	85mm	85mm	35mm

Polar Diagram

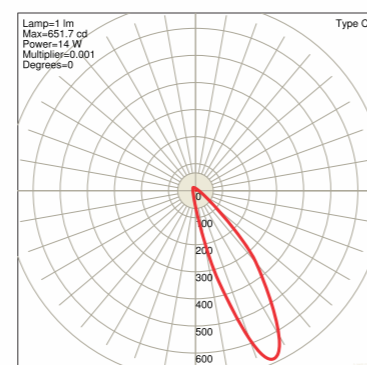

Product Descriptions	Product Code	Power (W)	Lumen (lm)	CRI	CCT	PF
LED Step Light 3W	HLPLEDSL2203CW	3	300	70	6000-6500k	0.95
LED Step Light 5W	HLPLEDSL2205CW	5	500	70	6000-6500k	0.95



Track Light

Product Features

- COB based fully adjustable LED track light
- 360° angle of rotation for LED track light
- Aesthetically Designed high grade aluminum housing
- High efficiency Led's for optimum light output and savings in power
- Short circuit & surge protection for enhanced reliability and longer service life of driver

Applications



Product Dimensions

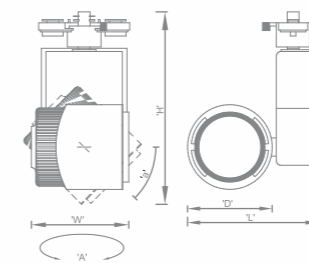

Wattage	'D' Diameter	'L' Length	'W' Width	'H' Height	'a' Tilting Angle	'A' Rotating Angle
23W	95mm	145mm	108mm	210mm	±45°	±175°
33W	95mm	145mm	108mm	210mm	±45°	±175°

Polar Diagram

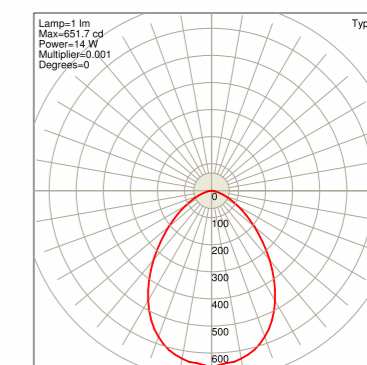

Product Descriptions	Product Code	Power (W)	Lumen (lm)	CRI	CCT	PF
Track Light 23W (CW)	HLPTRACK23(CW)	23	2300	80	6000-6500K	0.95
Track Light 33W (CW)	HLPTRACK33(CW)	33	3300	80	6000-6500K	0.95



Strip Light

Product Features

- High system efficacy
- High colour rendering index
- Color temperature 6000k/4000k/3000k
- Maintenance free
- Environmental friendly
- Long lifetime 50000 hours
- LED GLO is a replacement for equivalent 60W GLS

Applications



Product Dimensions

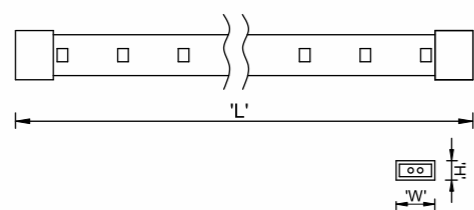

Wattage	'L' Length	'W' Width	'H' Height
8W	5 Mtr.	13mm	6.5mm
12W	5 Mtr.	13mm	6.5mm
12w	5 Mtr.	13mm	6.5mm

Polar Diagram

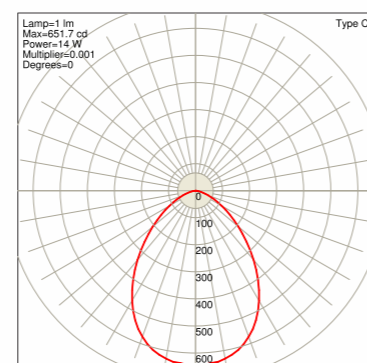

Strip Light (Without Driver) IP-20/65

Product Descriptions	Product Code	Power (W)	Lumen (lm)	CRI	CCT	PF
LED Strip 24W CW	HLPLS2420(CW)	24	312	65	6000-6500K	----
LED Strip 24W Blue	HLPLS2420(B)	24	430	----	465-470Nm	----
LED Strip 48W CW	HLPLS4820(CW)	48	600	65	6000-6500K	----
LED Strip 48W Blue	HLPLS4820(B)	48	630	----	465-470Nm	----
LED Strip 72W CW	HLPLS7220(CW)	72	900	65	6000-6500K	----
LED Strip 72W Blue	HLPLS7220(B)	72	1100	----	465-470Nm	----
LED Strip 24W CW	HLPLS2465(CW)	24	312	65	6000-6500K	----
LED Strip 24W Blue	HLPLS2465(B)	24	430	----	465-470Nm	----
LED Strip 48W CW	HLPLS4865(CW)	48	600	65	6000-6500K	----
LED Strip 48W Blue	HLPLS4865(B)	48	630	----	465-70Nm	----
LED Strip 72W CW	HLPLS7265(CW)	72	900	65	6000-6500K	----
LED Strip 72W Blue	HLPLS7265(B)	72	100	----	465-470Nm	----
LED Driver Strip 24W*	HLPLDRL024L001	24	----	----	----	0.9
LED Driver Strip 48W**	HLPLDRL048L001	48	----	----	----	0.9
LE Driver Strip 72W***	HLPLDRL072L001	72	----	----	----	0.9

Drives Option : *12/2A, **12/4A, ***12/6A

Strip Light (With Driver) IP-20/65

Product Descriptions	Product Code	Power (W)	Lumen (lm)	CRI	CCT	PF
LED Strip 24W	HLPLS24IP20(CW)	24	312	65	6000-6500K	----
LED Strip 24W	HLPLS24IP20(B)	24	430	----	465-470Nm	----
LED Strip 48W	HLPLS48IP20(CW)	48	600	65	6000-6500K	----
LED Strip 48W	HLPLS48IP20(B)	48	630	----	465-470Nm	----
LED Strip 72W	HLPLS72IP20(CW)	72	900	65	6000-6500K	----
LED Strip 72W	HLPLS72IP20(B)	72	1100	----	465-470Nm	----
LED Strip 24W	HLPLS24IP65(CW)	24	312	65	6000-6500K	----
LED Strip 24W	HLPLS24IP65(B)	24	430	----	465-470Nm	----
LED Strip 48W	HLPLS48IP65(CW)	48	600	65	6000-6500K	----
LED Strip 48W	HLPLS48IP65(B)	48	630	----	465-470K	----
LED Strip 72W	HLPLS72IP65(CW)	72	900	65	6000-6500K	----



LED Downlighters & Panels



LED Downlights & Panels are creating esthetics with better uniform illuminations in various commercial places. IT enhance the green energy at public places along with reduces carbon emissions.



Sleek Plus Round / Square

Product Features

- Solid sate high brightness SMD LED's for good quality illumination and longer life.
- Back lit illumination technology
- Excellent heat dissipation through high purity, high thermal conductivity heat sink.
- Special reflector system with high efficiency Translucence diffuser.
- On board short circuit and surge protections for reliable electrical system
- Wide beam angle of 120° with efficacy over 100Lm/ W.
- Available in Round & Square Shape.

Applications



Product Dimensions

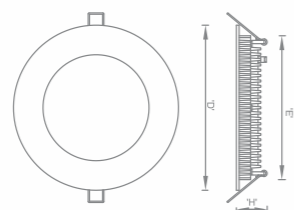

Wattage	'D' Diameter	'E' Cutout Dia	'H' Total Height
3W	84mm	71mm	40mm
6W	121mm	90mm	40mm
12W	150mm	124mm	40mm
15W	170mm	142mm	40mm
18W	170mm	142mm	40mm

Polar Diagram

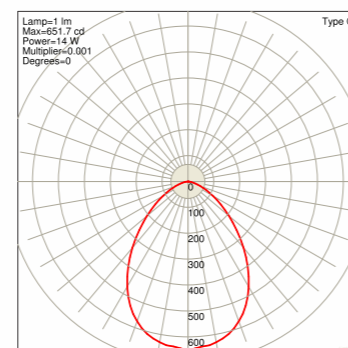

Product Descriptions	Product Code	Power (W)	Lumen (lm)	CRI	CCT	PF
Sleek Plus 3W(R)	HLPLEDRDL03CW	3	240	80	6000-6500K	0.95
Sleek Plus 6W(R)	HLPLEDRDL06CW	6	480	80	6000-6500K	0.95
Sleek Plus 12W(R)	HLPLEDRDL12CW	12	960	80	6000-6500K	0.95
Sleek Plus 15W(R)	HLPLEDRDL15CW	15	1200	80	6000-6500K	0.95
Sleek Plus 18W(R)	HLPLEDRDL18CW	18	1440	80	6000-6500K	0.95
Sleek Plus 3W(Sq)	HLPLEDSQDL03CW	3	240	80	6000-6500K	0.95
Sleek Plus 6W(Sq)	HLPLEDSQDL06CW	6	480	80	6000-6500K	0.95
Sleek Plus 12W(Sq)	HLPLEDSQDL12CW	12	960	80	6000-6500K	0.95
Sleek Plus 15W(Sq)	HLPLEDSQDL15CW	15	1200	80	6000-6500K	0.95
Sleek Plus 18W(Sq)	HLPLEDSQDL18CW	18	1440	80	6000-6500K	0.95



Jonex Plus Round / Square

Product Features

- Flat profile with wide-angle diffuser
- Housing made up of high heating conductive pure aluminum material
- Available in all color temperatures 6500K / 4000K / 2700K
- Highly efficient constant current drivers with additional protections
- Instant light with low running temperatures
- Surface mounting application
- Available in Round & Square Shape.

Applications



Product Dimensions

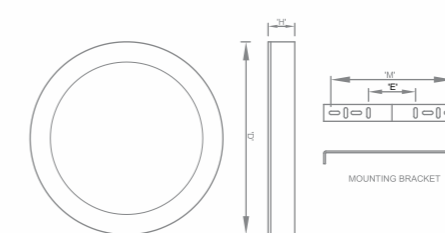

Wattage	'D' Diameter	'E' Mtg. Dis(Min)	'M' Mtg. Dis(Max)	'H' Height
6W	114mm	72mm	85mm	33mm
12W	172mm	110mm	145mm	33mm
18w	240mm	121mm	210mm	33mm

Polar Diagram

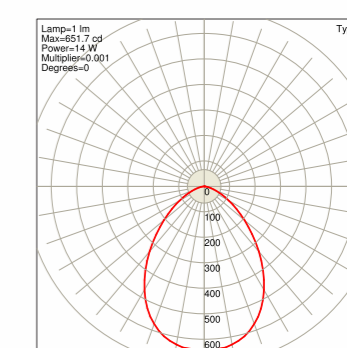

Product Descriptions	Product Code	Power (W)	Lumen (lm)	CRI	CCT	PF
Jonex Plus 6W (R)	HLPLEDSM06(CW)	6	420	70	6000-6500K	0.95
Jonex Plus 12W (R)	HLPLEDSM12(CW)	12	840	70	6000-6500K	0.95
Jonex Plus 15W (R)	HLPLEDSM15(CW)	15	1050	70	6000-6500K	0.95
Jonex Plus 18W (R)	HLPLEDSM18(CW)	18	1260	70	6000-6500K	0.95
Jonex Plus 6W (Sq)	HLPLEDSQSM06(CW)	6	420	70	6000-6500K	0.95
Jonex Plus 12W (Sq)	HLPLEDSQSM12(CW)	12	840	70	6000-6500K	0.95
Jonex Plus 15W (Sq)	HLPLEDSQSM15(CW)	15	1050	70	6000-6500K	0.95
Jonex Plus 18W (Sq)	HLPLEDSQSM18(CW)	18	1260	70	6000-6500K	0.95



Brighto Round / Square

Product Features

- Solid state high brightness SMD LED's for good quality illumination and longer life.
- Backlit Illumination technology
- Excellent heat dissipation through high purity, high thermal conductivity heat sink.
- Special reflector system with high efficiency Translucence diffuser.
- On board short circuit and surge protections for reliable electrical system
- Wide beam angle of 120° with efficacy over 80 Lm/W.
- Available in Round & Square Shape.

Applications



Product Dimensions

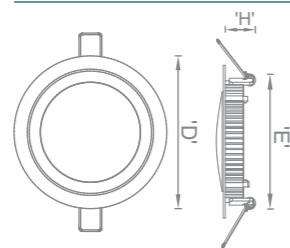

Wattage	'D' Diameter	'E' Cutout Dia	'H' Total Height
6W	115mm	100mm	40mm
12W	171mm	145mm	40mm
15W	171mm	145mm	40mm

Polar Diagram

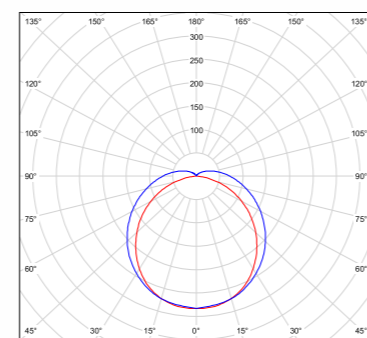

Product Descriptions	Product Code	Power (W)	Lumen (lm)	CRI	CCT	PF
Brighto LED 6W (R)	HPLEDRB06(CW)	6	480	80	5500-7000k	0.95
Brighto LED 12W (R)	HPLEDRB12(CW)	12	960	80	2700-3300k	0.95
Brighto LED 15W (R)	HPLEDRB15(CW)	15	1200	80	2700-3300k	0.95
Brighto LED 18W (R)	HPLEDRB18(CW)	18	1200	80	2700-3300k	0.95
Brighto LED 6W (Sq)	HPLEDSB06(CW)	6	480	80	5500-7000k	0.95
Brighto LED 12W (Sq)	HPLEDSB12(CW)	12	960	80	2700-3300k	0.95
Brighto LED 15W (Sq)	HPLEDSB15(CW)	15	1200	80	2700-3300k	0.95
Brighto LED 18W (Sq)	HPLEDSB18(CW)	18	1440	80	2700-3300k	0.95



Panel (AL)

Product Features

- Aluminum housing with soft and aesthetic bottom frame
- Excellent heat dissipation through high thermal conductivity MCPCB and housing
- High Efficiency Translucence (HET) diffuser
- Suitable for Armstrong / TRAC / GRG /USG / POP modular ceiling system
- Edge Lit Illumination technology
- High brightness SMD LED's for good quality illumination and longer life.

Applications



Product Dimensions

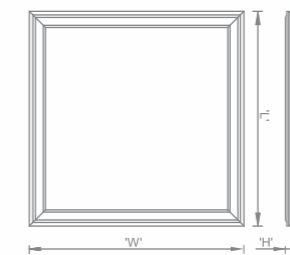

Wattage	'L' Length	'W' Width	'H' Height
18W	300mm	300mm	15mm
36W	600mm	600mm	15mm

Polar Diagram

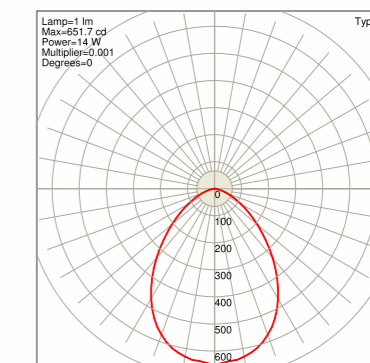

Product Descriptions	Product Code	Power (W)	Lumen (lm)	CRI	CCT	PF
LED Panel 18W	HLPLP1418(CW)	18	1250	70	6000-6500K	0.95
LED Panel 18W	HLPLP1418(WW)	18	1100	70	2700-3300K	0.95
LED Panel 36W	HLPLP1436(CW)	36	2700	70	6000-7000K	0.95
LED Panel 36W	HLPLP1436(WW)	36	2450	70	2700-3300K	0.95



CRCA Panel

Product Features

- CRCA powder coated housing with soft, aesthetic bottom frame
- Excellent heat dissipation through high thermal conductivity MCPCB and housing
- High Efficiency Translucence (HET) diffuser
- Suitable for Armstrong / TRAC / GRG /USG / POP modular ceiling system
- Back lit Illumination technology
- High brightness SMD LED's for good quality illumination and longer life.
- Available in 1x2 & 1x4 size.

Applications



Product Dimensions

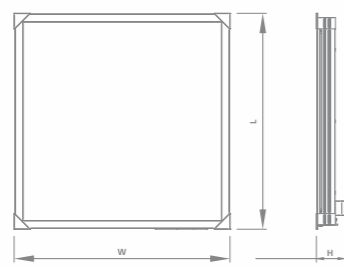

Wattage	'L' Length	'W' Width	'H' Height
18W	296mm	296mm	85mm
36W	596mm	596mm	85mm
30W1'x2'	597mm	295mm	85mm
36W1'x4'	1200mm	296mm	85mm

Polar Diagram

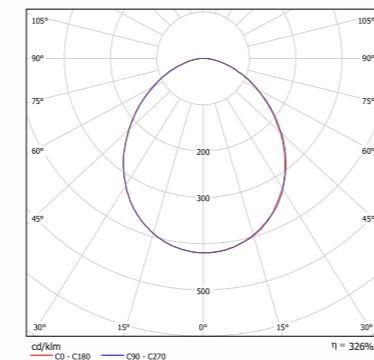

Product Descriptions	Product Code	Power (W)	Lumen (lm)	CRI	CCT	PF
CRCA Panel 18E	LEDPN18-E(CW)	18	1620	80	5500-6500K	0.95
CRCA Panel 36E	LEDPN36-E(CW)	36	3240	80	5500-6500K	0.95
CRCA Panel 30W 1x2	LEDPN30-E(CW)	30	2700	80	5500-6500K	0.95
CRCA Panel 36W 1x4	LEDPN36-E(CW)1x4	36	3240	80	5500-6500K	0.95



Clean Room

Product Features

- Cleanroom LED lighting fixtures are the cutting edge design in cleanroom lighting, sizes are available for various demand.
- Branded led driver with top quality component ensures long life.
- Our LED Cleanroom lights are natural outdoor color and produce a more even lighting for your cleanroom.

Applications



Product Dimensions

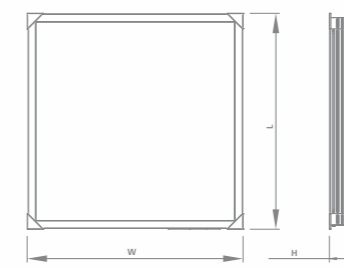

Wattage	'L' Length	'W' Width	'H' Height
80W	595mm	595mm	75mm

Polar Diagram

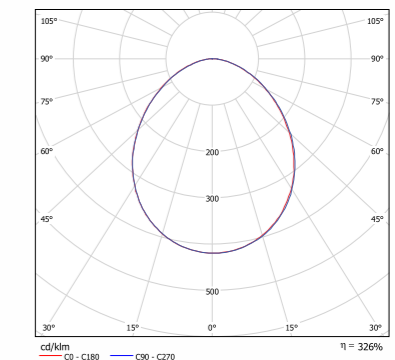

Product Descriptions	Product Code	Power (W)	Lumen (lm)	CRI	CCT	PF
Clean Room 40W	HLPLEDCR040CW	40	4000	80	6000-6500K	0.95
Clean Room 60W	HLPLEDCR060CW	60	6000	80	6000-6500K	0.95
Clean Room 80W	HLPLEDCR080CW	80	8000	80	6000-6500K	0.95



LED Tubes & Battens



LED products are BRIGHT! Besides being extremely efficient, premium LED products like LifeSpec Lighting lights have a very high lumen output, which results in a very well lit and comfortable environment. Retrofit customers can expect a space which is 20-30% brighter than pre-retrofit.



Indus T8

Product Features

- High efficiency Led's for optimum light output and savings in power.
- High quality PC cover for LED linear lamp ensures soft and glare free lighting.
- Specially designed aluminium housing for excellent Heat dissipation.
- Short circuit & surge protection for enhanced reliability and longer service life of driver.
- Wide beam angle of 120° with efficacy over 100 Lm/ W.
- Retrofit Solution.

Applications



Product Dimensions

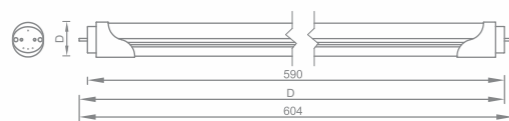

Wattage	'L' Length	'D' Dia
10W	600mm	26mm
20W	1200mm	26mm

Polar Diagram

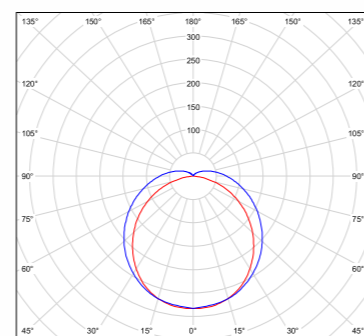

Product Descriptions	Product Code	Power (W)	Lumen (lm)	CRI	CCT	PF
INDUS AL 10W (T8)	HLPT81410(CW)	10	1000	80	6000-6500k	0.95
INDUS AL 20W (T8)	HLPT81420(CW)	20	2000	80	6000-6500k	0.95



Indus PC T8

Product Features

- High efficiency Led's for optimum light output and savings in power .
- High quality PC cover for LED linear lamp ensures soft and glare free lighting
- Specially designed PC Housing for excellent Heat dissipation .
- Short circuit & surge protection for enhanced reliability and longer service life of driver
- Wide beam angle of 120° with efficacy over 100 Lm/ W.
- Retrofit Solution.

Applications



Product Dimensions



Wattage	'L' Length	'D' Dia
9W	570mm	16mm
18W	1170mm	16mm

Polar Diagram

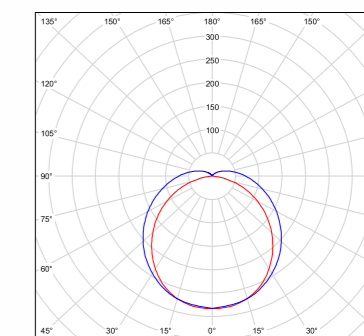

Product Descriptions	Product Code	Power (W)	Lumen (lm)	CRI	CCT	PF
INDUS PC 9W (T8)	HLPT81409PC(CW)	9	900	80	6000-6500k	0.9
INDUS PC 18W (T8)	HLPT81418PC(CW)	18	1800	80	6000-6500k	0.9
INDUS PC 18W (T8) SSP	HLPT81418PCSS(CW)	18	1800	80	6000-6500k	0.9
INDUS PC 20W (T8)	HLPT81420PC(CW)	20	2000	80	6000-6500k	0.9



Indus T5

Product Features

- Replacement of T-5 conventional lamps with external Driver
- High efficiency Led's for optimum light output and savings in power .
- High quality PC Diffuser for LED linear lamp ensures soft and glare free lighting
- Specially designed aluminum housing for excellent Heat dissipation .
- Short circuit and surge protection for enhanced reliability and longer service life of driver
- Wide beam angle of 120° with efficacy over 100 Lm/W.

Applications



Product Dimensions

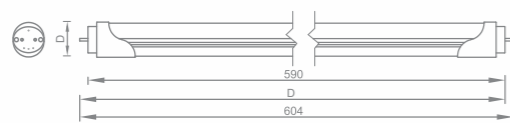

Wattage	'L' Length	'D' Dia
9W	570mm	16mm
18W	1170mm	16mm

Polar Diagram

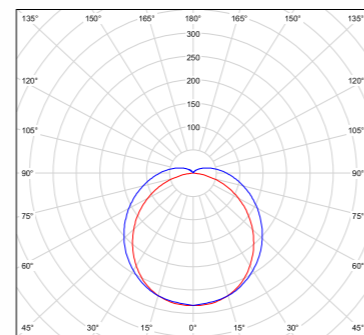

Product Descriptions	Product Code	Power (W)	Lumen (lm)	CRI	CCT	PF
INDUS 9W (T5)	HLPT51409(CW)	9	1000	80	6000-6500k	0.9
INDUS 18W (T5)	HLPT51418(CW)	18	1800	80	6000-6500k	0.9



Neptune Plus

Product Features

- Replacement of T-5 conventional lamps with external Driver
- High efficiency Led's for optimum light output and savings in power .
- High quality PC Diffuser for LED linear lamp ensures soft and glare free lighting
- Specially designed aluminum housing for excellent Heat dissipation .
- Short circuit and surge protection for enhanced reliability and longer service life of driver
- Wide beam angle of 120° with efficacy over 100 Lm/W.

Applications



Product Dimensions

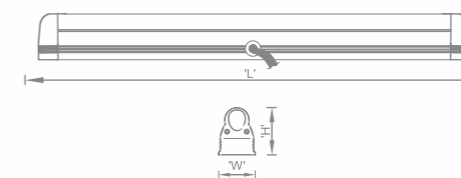

Wattage	'L' Length	'W' Width	'H' Height
5W	310mm	27mm	34mm
10W	620mm	27mm	34mm
20W	1200mm	27mm	34mm

Polar Diagram

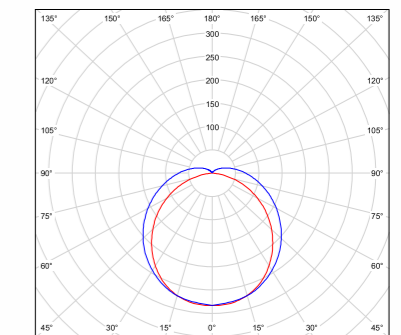

Product Descriptions	Product Code	Power (W)	Lumen (lm)	CRI	CCT	PF
Neptune Plus (AL) 5W	HLPT51505CW	5	500	80	5500-7000k	0.95
Neptune Plus (AL) 10W	HLPT51510CW	10	1000	80	5500-7000k	0.95
Neptune Plus (AL) 20W	HLPT51520CW	20	2000	80	5500-7000k	0.95



Neptune Silver

Product Features

- Engineered & designed Linear sleek Asthetic PVC housing
- High efficiency Led's for optimum light output and savings in power .
- High quality PC cover for LED linear lamp ensures soft and glare free lighting
- Short circuit and surge protection for enhanced reliability and longer service life of driver
- Wide beam angle of 120° with efficacy over 100 Lm/ W.

Applications



Polar Diagram

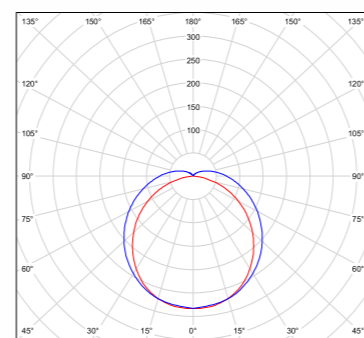

Product Dimensions

Wattage	'D' Diameter	'E' Cutout Dia	'H' Total Height
5W	110mm	90mm	40mm
9W	145mm	125mm	40mm
20W	165mm	145mm	40mm
	165mm	145mm	40mm

Product Descriptions	Product Code	Power (W)	Lumen (lm)	CRI	CCT	PF
Neptune Silver 5W	HLPT51505PCGCW	5	500	80	5500-7000k	0.95
Neptune Silver 9W	HLPT51509PCGCW	9	900	80	5500-7000k	0.95
Neptune Silver 20W	HLPT51520PCGCW	20	2000	80	5500-7000k	0.95



PLL Lamp

Product Features

- Perfect for 2' x 2' fixtures in office and healthcare facilities.
- PL-L offers long life in a sleek profile.
- 24 month warranty

Applications



Polar Diagram

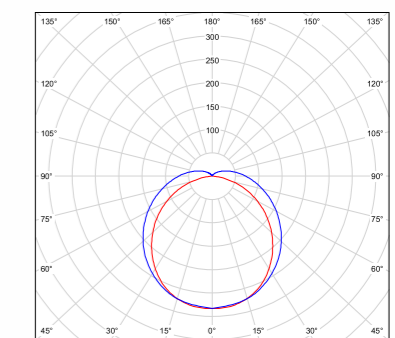

Product Dimensions

Wattage	'L' Length	'W' Width
9w	235mm	45mm
18w	410mm	45mm

Product Descriptions	Product Code	Power (W)	Lumen (lm)	CRI	CCT	PF
LED PLL Lamp 9W	HPLEDPL09W(CW)	9	900	80	5700-6000K	0.9
LED PLL Lamp 18W	HPLEDPL18W(CW)	18	1800	80	5700-6000K	0.9